



4" TC REMODEL HOUSING

INCANDESCENT LAMPS

TC1RCW

Project: _____

Fixture Type: _____

Location: _____

Contact/Phone: _____

PRODUCT DESCRIPTION

TC Remodel Housing designed for use in non-insulated areas

- Juno Type TC fixtures are designed for installations where housing and J-Box will not come into contact with insulation
- Blinking light after installation indicates that improper bulb or trim is being used or that fixture has been improperly covered with insulation
- In U.S., insulation must be spaced 3" away from the housing and J-Box
- TC Remodel Housing for remodel application where back side of ceiling is not accessible
- Installs through an opening in the ceiling from below
- Secured in place by factory installed screw driven remodel clamps for easy installation into ceiling material.

PRODUCT SPECIFICATIONS

Lamp Lamp ratings based on trim selected – see reverse.

Socket Detachable medium base porcelain with nickel-plated copper screw shell.

Trims Trim selection shown on reverse.

Labels UL/cUL listed for U.S. and Canada through-branch wiring and damp locations

- Product thermally protected against improper use of insulation
- UL/cUL Listed
- Trim No. 11, 12, 12SQ, 4101, 4102, V4012 and V4041 are wet location approved for covered ceiling applications
- Trims 14, 17, 17SQ, V4017 and V4034 are wet location approved for covered ceiling applications, **when used with outdoor rated lamps.**

Testing All reports are based on published industry procedures; field performance may differ from laboratory performance.

Product specifications subject to change without notice.

INSTALLATION

Junction Box Pre-wired junction box, UL/cUL listed for through-branch wiring maximum 4 No. 12 AWG 90° C branch circuit conductors (2 in, 2 out)

- Junction box provided with removable access plate, (5) 1/2" knockouts, (4) Non-metallic sheathed cable connectors and ground wire
- Knockouts equipped with pryout slots
- Supplied with push-in electrical connectors for fast installation.

Housing TC housing, 22-gauge steel with white finish

- Remodel clamps provided with #2 Quadrex drive screws (#2 Robertson/#2 Phillips combo)
- Clamps accommodate up to a 7/8" ceiling thickness.

PRODUCT CODES

Catalog Number	Input Voltage	Lamp Types
TC1RCW	120V	PAR20/PAR16 Medium Base, MR16/PAR16/ES16 GU10 Base (See reverse for Trim/Lamp/Max. Wattage Ratings)



DIMENSIONS

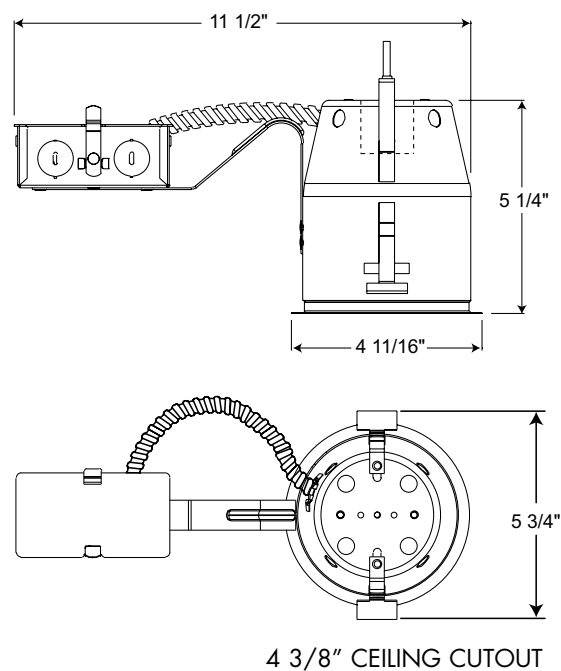

ACCESSORIES

Catalog No.	Description
GU10-WHIP	GU10 Socket Whip
SMPLT-4	4" Housing Locator

















To order, specify catalog number.

4" TC REMODEL HOUSING

INCANDESCENT LAMPS

TC1RCW







ROUND TRIMS/LAMPS

Cat. No.	Description	Max. Lamp Rating
 13-WH	2" Pinhole with Integral Shield	50W PAR20
 14B-WH ♦♦ 14B-SC ♦♦ 14B-ABZ ♦♦ 14B-BL ♦♦ 14W-WH ♦♦	Black Baffle Black Baffle Black Baffle Black Baffle White Baffle	50W PAR20
 17C-WH ♦♦ 17G-WH ♦♦ 17B-WH ♦♦ 17PT-SC ♦♦ 17W-WH ♦♦ 17HZ-WH ♦♦ 17WHZ-WH ♦♦ 17WHZ-ABZ ♦♦	Cone - Clear Alzak® Cone - Gold Alzak® Cone - Black Alzak® Cone - Pewter Alzak® Cone - Gloss White Cone - Haze Cone - Wheat Haze Cone - Wheat Haze	50W PAR20
 10-WH 10-BL 10-SC 10-ABZ	Push-In Flush Gimbal Ring Push-In Flush Gimbal Ring Push-In Flush Gimbal Ring Push-In Flush Gimbal Ring	50W PAR20
 18-WH 18-SC	Mini Eyeball Mini Eyeball	60W PAR16
 440-WH 440-BL 440-SC 440-ABZ	Flush Gimbal Ring Flush Gimbal Ring Flush Gimbal Ring Flush Gimbal Ring (New tighter gap, uses 2" optical media)	50W MR16, PAR16, ES16 120V GU10 Base (Requires GU10-WHIP)
 445-WH	Slot Aperture Downlight or Adjustable	50W MR16, PAR16, ES16 120V GU10 Base (Requires GU10-WHIP)
 448-WH 448-SC	Eyeball with Black Baffle Eyeball with Black Baffle	50W MR16, PAR16, ES16 120V GU10 Base (Requires GU10-WHIP)
 11-WH ♦	Drop Opal	50W PAR20
 12W-WH ♦ 12W-SC ♦ 12W-ABZ ♦	Shower Trim, frosted perimeter lens Shower Trim, frosted perimeter lens Shower Trim, frosted perimeter lens	50W PAR20
 446-WH	Scoop Adjustable	50W MR16, PAR16, ES16 120V GU10 Base (Requires GU10-WHIP)
 4101-WH ♦ 4101-SC ♦ 4101-ABZ ♦	Beveled Dome Shower Beveled Dome Shower Beveled Dome Shower	50W PAR20
 4102-WH ♦ 4102-SC ♦ 4102-ABZ ♦	Beveled Shower Beveled Shower Beveled Shower	50W PAR20
 4103FROST-WH 4103FROST-SC	Beveled Cylinder Beveled Cylinder	50W PAR20
 4104HZ-SC 4104WHZ-ABZ	Beveled Cone Beveled Cone	50W PAR20
 4150MESH-SC	Cylinder	50W PAR20









♦ UL Listed for use in wet location.

♦♦ UL Listed for use in wet location with outdoor rated lamp.

SQUARE TRIMS/LAMPS

Cat. No.	Description	Max. Lamp Rating
 175Q-HZ-WH ♦♦	Square Downlight - Haze Reflector	50W PAR20
 175Q-W-WH ♦♦	Square Downlight - White Reflector	
 175Q-B-WH ♦♦	Square Downlight - Black Alzak Reflector	
 175Q-WHZ-WH ♦♦	Square Downlight - Wheat Haze Reflector	
 135Q-WH	Square Pinhole	50W PAR20
 440SQ-WH 440SQ-BL	Square Flush Gimbal	50W MR16 120V GU10 Base (Requires GU10-WHIP) 35° Vertical Adjustment
 125Q-W-WH ♦	Square Frosted Lens with Clear Center	50W PAR20

VULITE TRIMS/LAMPS

Cat. No.	Description	Max. Lamp Rating
 V4034W-WH ♦♦ V4034B-WH ♦♦	White Baffle Black Baffle	50W PAR20
 V4017C-WH ♦♦	Clear Cone	50W PAR20
 V4010-WH V4010-BN	White Gimbal Ring Brushed Nickel Gimbal Ring	50W PAR20
 V4018-WH	White Eyeball	60W PAR16
 V4012-WH ♦	Stippled Opal Lens Shower with Reflector	50W PAR20
 V4040-WH V4040-BN	White MR16 Gimbal Ring Brushed Nickel MR16 Gimbal Ring	50W MR16 PAR16, ES16 120V GU10 Base (Requires GU10-WHIP)
 V4041-WH	MR16 Stippled Opal Lens Shower	50W MR16 PAR16, ES16 120V GU10 Base (Requires GU10-WHIP)
 V4048-WH	MR16 Eyeball with Baffle	50W MR16 PAR16, ES16 120V GU10 Base (Requires GU10-WHIP)
 GU10-WHIP	GU10 Socket Whip	

Trim Size: 5" O.D.

Trim Finish: ABZ - Classic Aged Bronze, BL - Black, SC - Satin Chrome, SL - Silver, WH - White.

Alzak is a registered trademark of Alcoa Corp.

Note: In Canada when insulation is present, Type IC fixtures must be used.

JUNO

Projet: _____

Type de luminaire: _____

Lieu: _____

Contact/téléphone: _____

DESCRIPTION DE PRODUIT

Boîtier de rénovation TC conçu pour les zones non-isolées

- Les luminaires Juno de type TC sont conçus pour des installations où le boîtier et le boîtier de raccordement n'entreront pas en contact avec le matériau d'isolation
- Le clignotement après l'installation indique que la mauvaise ampoule ou garniture a été montée ou que le luminaire a été indûment recouvert de matériau isolant
- Aux États-Unis, l'isolant doit être à au moins 3 po (7,5 cm) de boîtier et du boîtier de raccordement
- Boîtier de rénovation TC pour les applications de rénovation quand l'arrière du plafond n'est pas accessible
- Se monte par une ouverture dans le plafond depuis la partie inférieure
- Fixé en place par des colliers de rénovation maintenu par une vis d'usine pour l'installation facile dans le matériau de plafond

CARACTÉRISTIQUES DE PRODUIT

Lampe Les classements de lampe sont basés sur la garniture sélectionnée - voir au verso.

Douille Porcelaine culot moyen amovible avec enveloppe en cuivre plaque.

Garnitures La sélection de garniture figure au verso.

Autocollants Homologués pour le câblage UL/cUL aux États-Unis et au Canada en série et dans les lieux humides

- Produit avec protection thermique contre l'utilisation inapproprié d'isolants
- Homologué UL/cUL
- Garnitures No. 11, 12, 12SQ, 4101, 4102, V4012 et V4041 homologuées pour des lieux humides pour des applications pour plafond ferme
- Les garnitures 14, 17, 17SQ, V4017 et V4034 sont homologuées pour des applications en lieux humides pour plafond ferme, **quand elles sont utilisés avec des lampes classées plein-air.**

Tests Tous les rapports sont basés sur des procédures publiées du secteur; les résultats sur le terrain peuvent différer des résultats en laboratoire.

Caractéristiques sujettes à des modifications sans avertissement préalable.

MONTAGE

Boîtier de raccordement Boîtier de raccordement précâblé, homologué pour un raccordement en série d'un maximum de 4 conducteurs de circuits de dérivation No. 12 AWG 90° C (2 entrées, 2 sorties)

- Le boîtier de raccordement est fourni avec une plaque d'accès amovible, (5) découpes de 1/2 po, (4) connecteurs de câble gainée non métallique et fil de terre
- Découpes dotées de fentes d'extraction
- Fournis avec connecteurs électriques poussables pour un montage rapide.

Boîtier Boîtier TC, en acier de calibre 22 avec finition blanche

- Colliers de rénovation avec vis d'entraînement Quadrex No.2 (combinaison Robertson et philips)
- Les brides s'adaptent une épaisseur de plafond maximale de 7/8 po (22,22 mm).

CODES DE PRODUITS

Numéro de catalogue	Tension d'entrée	Types de lampes
TC1RCW	120V	PAR20/PAR16, culot moyen, MR16/PAR16/ES16 Culot GU10 (voir au verso pour classement de puissance /Maxi/Garniture/Lampe)

BOITIER DE RÉNOVATION TC 4 PO

LAMPES INCANDESCENTES TC1RCW



DIMENSIONS

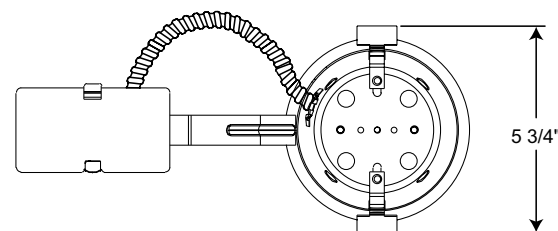
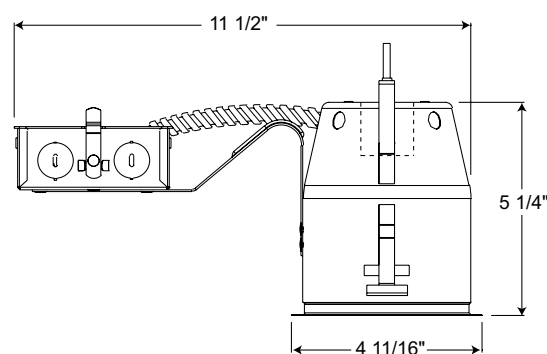

DÉCOUPAGE DE PLAFOND
DE 4 3/8 PO (11,16 CM)

ACCESSOIRES

No. de catalogue	Désignation
GU10-WHIP	Adaptateur à queue de douille GU10
SMPLT-4	Repère de logement de 4 po (10 cm)



















Pour passer commande, indiquez le numéro de catalogue.

BOITIER DE RÉNOVATION TC 4 PO

LAMPES INCANDESCENTES







TC1RCW

GARNITURES RONDES / AMPOULE









No. Cat.	Désignation	Puissance maximale de lampe
 13-WH	Trou d'épingle de 2 po avec écran intégré	50W PAR20
 14B-WH ♦♦ 14B-SC ♦♦ 14B-ABZ ♦♦ 14B-BL ♦♦ 14W-WH ♦♦	Écran noir Écran noir Écran noir Écran noir Écran blanc	50W PAR20
 17C-WH ♦♦ 17G-WH ♦♦ 17B-WH ♦♦ 17PT-SC ♦♦ 17W-WH ♦♦ 17HZ-WH ♦♦ 17WHZ-WH ♦♦ 17WHZ-ABZ ♦♦	Cône - Alzak® transparent Cône - Alzak® doré Cône - Alzak® noir Cône - Alzak® étain Cône - Blanc brillant Cône - Brume Cône - Brume de blé Cône - Brume de blé	50W PAR20
 10-WH 10-BL 10-SC 10-ABZ	Anneau affleurant poussable Anneau affleurant poussable Anneau affleurant poussable Anneau affleurant poussable	50W PAR20
 18-WH 18-SC	Mini globe oculaire Mini globe oculaire	60W PAR16
 440-WH 440-BL 440-SC 440-ABZ	Anneau affleurant Anneau affleurant Anneau affleurant Anneau affleurant (Nouvel espace plus étroit, utilise un médium optique de 2 po)	50W MR16, PAR16, ES16 120V GU10 Base (Exige GU10-WHIP)
 445-WH	Downlight à ouverture en fente ou réglable	50W MR16, PAR16, ES16 120V GU10 Base (Exige GU10-WHIP)
 448-WH 448-SC	Globe oculaire avec écran noir Globe oculaire avec écran noir	50W MR16, PAR16, ES16 120V GU10 Base (Exige GU10-WHIP)
 11-WH ♦	Opale en suspension	50W PAR20
 12W-WH ♦	Garniture douche à lentille à périmètre dépoli	50W PAR20
 12W-SC ♦	Garniture douche à lentille à périmètre dépoli	50W PAR20
 12W-ABZ ♦	Garniture douche à lentille à périmètre dépoli	50W PAR20
 446-WH	Écoper réglable	50W MR16, PAR16, ES16 120V GU10 Base (Exige GU10-WHIP)
 4101-WH ♦ 4101-SC ♦ 4101-ABZ ♦	Douche à dôme chanfreiné Douche à dôme chanfreiné Douche à dôme chanfreiné	50W PAR20
 4102-WH ♦ 4102-SC ♦ 4102-ABZ ♦	Douche chanfreinée Douche chanfreinée Douche chanfreinée	50W PAR20
 4103FROST-WH 4103FROST-SC	Cylindre chanfreiné Cylindre chanfreiné	50W PAR20
 4104HZ-SC 4104WHZ-ABZ	Cône chanfreiné Cône chanfreiné	50W PAR20
 4150MESH-SC	Cylindre	50W PAR20

♦ Homologué par UL pour une utilisation dans des lieux humides.

GARNITURES CARRÉES / AMPOULE

No. Cat.	Désignation	Puissance maximale de lampe
 175Q-HZ-WH ♦♦	Downlight carré - Brume réflecteur	50W PAR20
 175Q-W-WH ♦♦	Downlight carré - Blanc réflecteur	50W PAR20
 175Q-B-WH ♦♦	Downlight carré - Alzak noir réflecteur	50W PAR20
 175Q-WHZ-WH ♦♦	Downlight carré - Brume de blé réflecteur	50W PAR20
 135Q-WH	Trou d'épingle carré	50W PAR20
 4405Q-WH 4405Q-BL	Anneau affleurant carré	50W MR16 Culot GU10 de 120V (Exige GU10-WHIP) Réglage vertical 35°
 125Q-W-WH ♦	Lentille dépolie carrée à centre transparent	50W PAR20

GARNITURES/LAMPES VULITE

No. Cat.	Désignation	Puissance maximale de lampe
 V4034W-WH ♦♦ V4034B-WH ♦♦	Écran blanc Écran noir	50W PAR20
 V4017C-WH ♦♦	Cône transparent	50W PAR20
 V4010-WH V4010-BN	Anneau blanc Anneau en nickel brossé	50W PAR20
 V4018-WH	Globe oculaire blanc	60W PAR16
 V4012-WH ♦	Lentille opale grenée Douche avec réflecteur	50W PAR20
 V4040-WH V4040-BN	Anneau MR16 blanc Anneau MR16 en nickel brossé	50W MR16 PAR16, ES16 120V GU10 Base (Exige GU10-WHIP)
 V4041-WH	MR16 Grenée pointillé lentille opale	50W MR16 PAR16, ES16 120V GU10 Base (Exige GU10-WHIP)
 V4048-WH	MR16 Boule orientable	50W MR16 PAR16, ES16 120V GU10 Base (Exige GU10-WHIP)
 GU10-WHIP	Adaptateur à queue de douille GU10	

Taille de garniture: 5 po dia. ext.

Finition de la garniture: ABZ - Bronze âgé classique, BL - Noir, SC - Chrome satiné, SL - Argent, WH - Blanc.

Alzak est une marque déposée d'Alcoa Corp.

Remarque: Au Canada quand l'isolation est présente, des luminaires de type IC doivent être utilisés.

♦♦ Homologué par UL pour une utilisation dans un lieu humide avec une lampe de qualité extérieure.